

DOCUMENT	BXPBAL12212091-A01
VERSION	1.0
FORM	TECHNICAL INFORMATION



ALUMINIUM ENCLOSURE SERIES ALSTER

ORDER NO.: BXPBAL12212091-A01

EAN: 4260543453312



DESCRIPTION

PRODUCTTYPE:	ALUMINIUM ENCLOSURE
OUTER DIMENSIONS:	122x120x91mm
INNER DIMENSIONS:	108x106x82mm (MINUS MOUNTING AREA)
COLOUR:	RAL7001 SILVER GREY
WEIGHT:	1013g
MATERIALS:	ALUMINIUM
MATERIAL SEAL:	PU FOAMED
SCOPE OF DELIVERY:	UPPER AND LOWER PART, NON-RUSTING COVER SCREWS, GROUND SCREWS

TECHNICAL DATA

PROTECTION DEGREE:	IP 66 as per DIN EN 60529/DIN 40050
IMPACT RESISTANCE:	IK09
OPERATING TEMPERATURE:	-40 °C ... +100°C as per DIN EN 60670
RESISTANCE:	ALKALI, OILS, SALTS, ETC.
APPROVAL:	CE, ROHS

ACCESSORIES

MOUNTING PLATE:	AVAILABLE
MOUNTING RAIL:	AVAILABLE
CABEL GLAND:	AVAILABLE
MOUNTING BRACKETS:	AVAILABLE

RESTRICTED INFORMATION HANDED OUT BY BREUELL INGENIEURBÜRO GMBH. ANY UNAUTHORISED COPYING, DISCLOSURE OR DISTRIBUTION OF THE MATERIAL IN THIS DOCUMENT IS STRICTLY FORBIDDEN. PRIOR ACKNOWLEDGEMENT REQUESTED.

DOCUMENT	BXPBAL12212091-A01
VERSION	1.0
FORM	TECHNICAL INFORMATION

TECHNICAL DRAWING

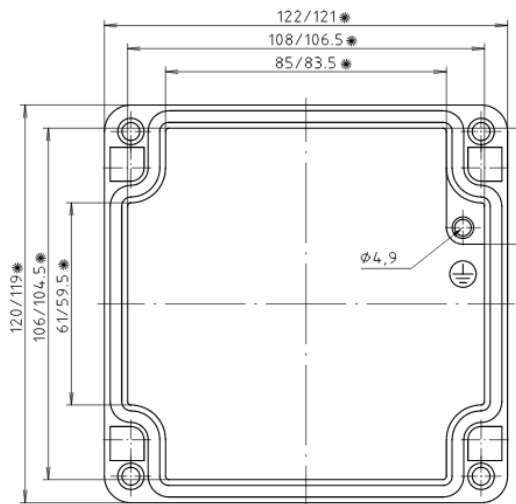

Deckel / lid

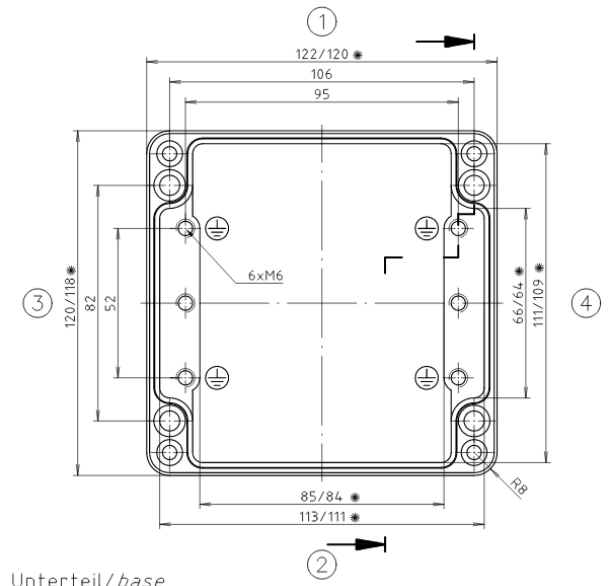

Unterteil / base

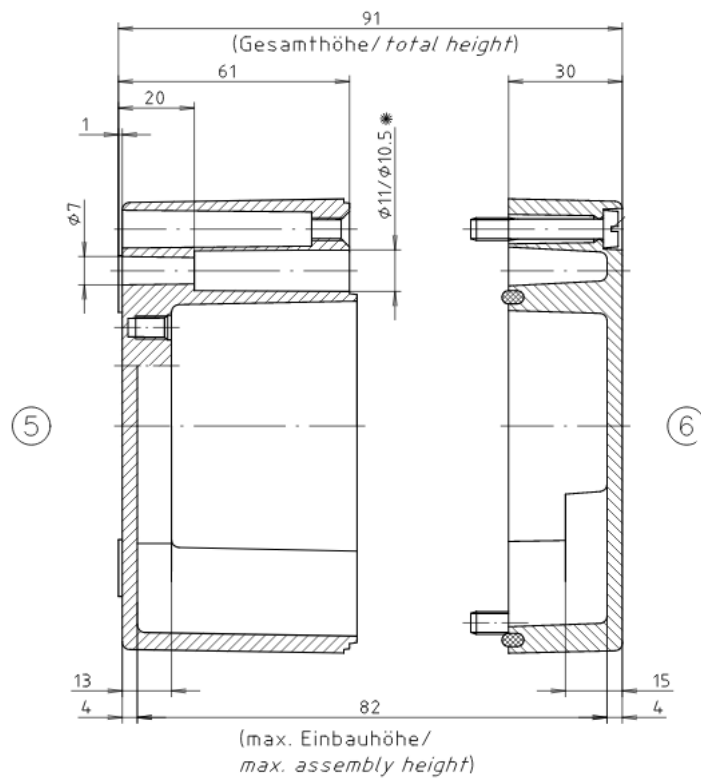

RESTRICTED INFORMATION HANDED OUT BY BREUELL INGENIEURBÜRO GMBH. ANY UNAUTHORISED COPYING, DISCLOSURE OR DISTRIBUTION OF THE MATERIAL IN THIS DOCUMENT IS STRICTLY FORBIDDEN. PRIOR ACKNOWLEDGEMENT REQUESTED.