

DOCUMENT	BXPBAL22012081-A01
VERSION	1.0
FORM	TECHNICAL INFORMATION



## ALUMINIUM ENCLOSURE SERIES ALSTER

ORDER NO.: BXPBAL22012081-A01

EAN: 4260543453343



### DESCRIPTION

---

<b>PRODUCTTYPE:</b>	ALUMINIUM ENCLOSURE
<b>OUTER DIMENSIONS:</b>	220x120x81 mm
<b>INNER DIMENSIONS:</b>	206x106x72 mm (MINUS MOUNTING AREA)
<b>COLOUR:</b>	RAL7001 SILVER GREY
<b>WEIGHT:</b>	1500g
<b>MATERIALS:</b>	ALUMINIUM
<b>MATERIAL SEAL:</b>	PU FOAMED
<b>SCOPE OF DELIVERY:</b>	UPPER AND LOWER PART, NON-RUSTING COVER SCREWS, GOUND SCREWS

### TECHNICAL DATA

---

<b>PROTECTION DEGREE:</b>	IP 66 as per DIN EN 60529/DIN 40050
<b>IMPACT RESISTANCE:</b>	IK09
<b>OPERATING TEMPERATURE:</b>	-40 °C ... +100°C as per DIN EN 60670
<b>RESISTANCE:</b>	ALKALI, OILS, SALTS, ETC.
<b>APPROVAL:</b>	CE, ROHS

### ACCESSORIES

---

<b>MOUNTING PLATE:</b>	AVAILABLE
<b>MOUNTING RAIL:</b>	AVAILABLE
<b>CABEL GLAND:</b>	AVAILABLE
<b>MOUNTING BRACKETS:</b>	AVAILABLE

RESTRICTED INFORMATION HANDED OUT BY BREUELL INGENIEURBÜRO GMBH. ANY UNAUTHORISED COPYING, DISCLOSURE OR DISTRIBUTION OF THE MATERIAL IN THIS DOCUMENT IS STRICTLY FORBIDDEN. PRIOR ACKNOWLEDGEMENT REQUESTED.

DOCUMENT	BXPBAL22012081-A01
VERSION	1.0
FORM	TECHNICAL INFORMATION

## TECHNICAL DRAWING

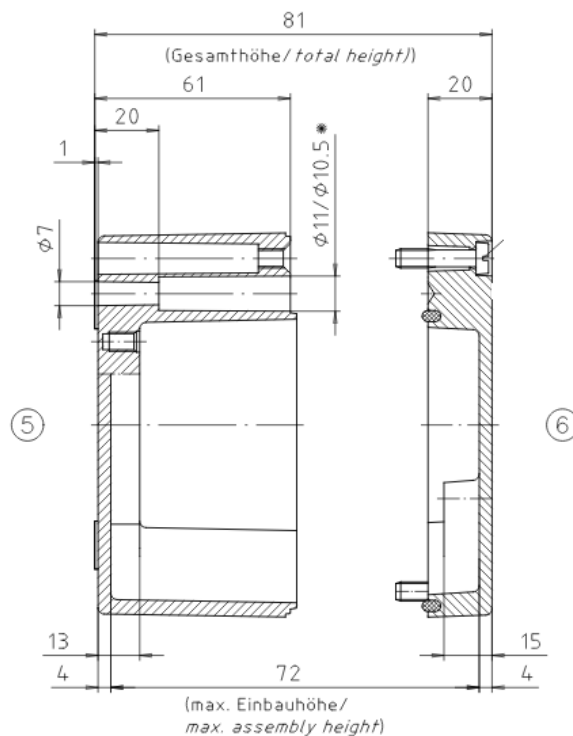
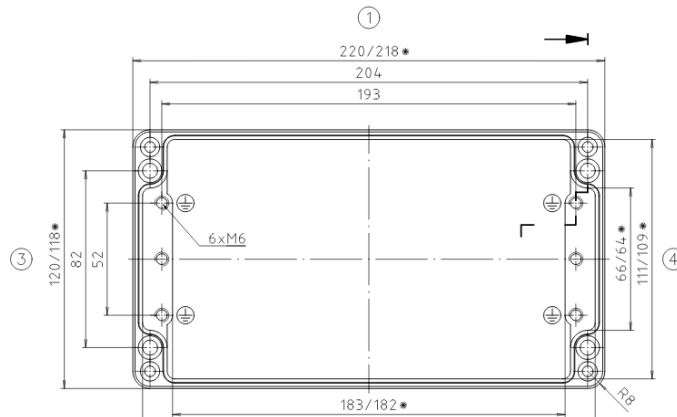
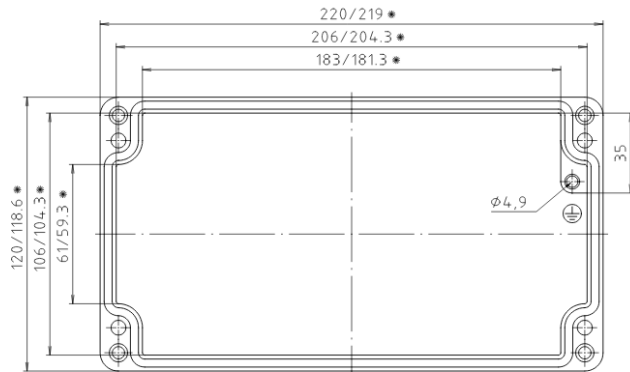

RESTRICTED INFORMATION HANDED OUT BY BREUELL INGENIEURBÜRO GMBH. ANY UNAUTHORISED COPYING, DISCLOSURE OR DISTRIBUTION OF THE MATERIAL IN THIS DOCUMENT IS STRICTLY FORBIDDEN. PRIOR ACKNOWLEDGEMENT REQUESTED.