

DOCUMENT	BXPPABSB400500180-F01
VERSION	1.0
FORM	TECHNICAL INFORMATION



WALL MOUNTING CABINET SERIES FLEET BLACKLINE



ORDER NO.: BXPPABSB400500180-F01

EAN: 4260543453169

DESCRIPTION

PRODUCTTYPE:	WALL MOUNTING CABINET
OUTER DIMENSIONS:	400x500x180 mm
INNER DIMENSIONS:	457x351x166 mm (MINUS MOUNTING AREA)
CLOSURE:	DOOR WITH HINGE ON THE LONG SIDE AND 2-POINT CLOSURE
COLOUR:	RAL 9005 BLACK
WEIGHT:	4300g
MATERIALS:	ABS
SCOPE OF DELIVERY:	BASE, DOOR WITH RUBBER GASKET, MOUNTING PLATE (SHEET STEEL, GALVANIZED), 4 PCS. WALL MOUNTING BRACKET, TRIANGLE LOCKING KEY, MOUNTING SCREWS

TECHNICAL DATA

PROTECTION DEGREE:	IP65
IMPACT RESISTANCE:	IK08
OPERATING TEMPERATURE:	-35°C... +65°C
RESISTANCE:	ALKALI, OILS, SALTS, ETC.
APPROVAL:	CE, ROHS

ACCESSORIES

MOUNTING PLATE:	INCLUDED
WALL MOUNTING BRACKET:	INCLUDED
SECURITY LOCK:	AVAILABLE (BXPPLOCK)

RESTRICTED INFORMATION HANDED OUT BY BREUELL INGENIEURBÜRO GMBH. ANY UNAUTHORISED COPYING, DISCLOSURE OR DISTRIBUTION OF THE MATERIAL IN THIS DOCUMENT IS STRICTLY FORBIDDEN. PRIOR ACKNOWLEDGEMENT REQUESTED.

DOCUMENT	BXPPABSB400500180-F01
VERSION	1.0
FORM	TECHNICAL INFORMATION

TECHNICAL DRAWING

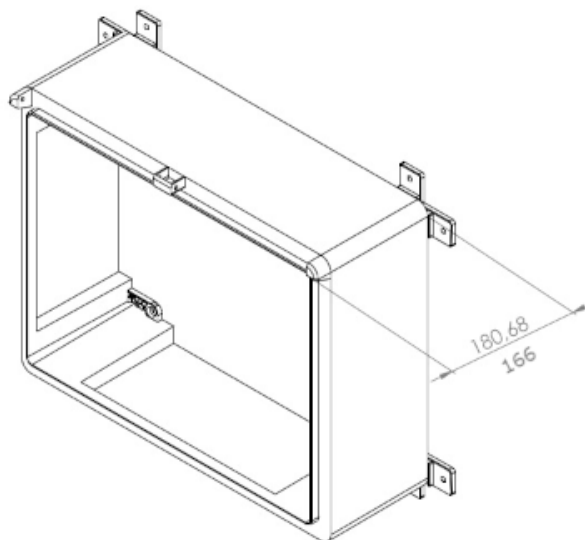
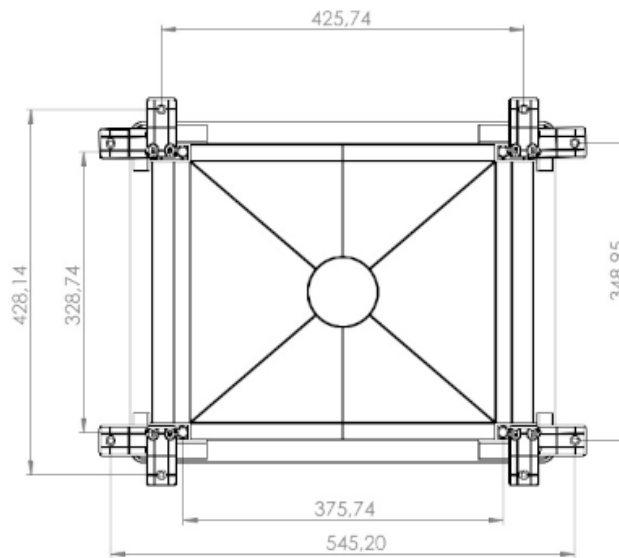
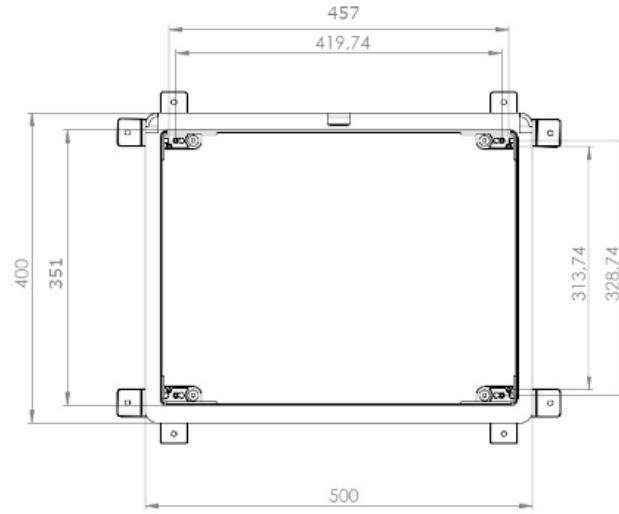

RESTRICTED INFORMATION HANDED OUT BY BREUELL INGENIEURBÜRO GMBH. ANY UNAUTHORISED COPYING, DISCLOSURE OR DISTRIBUTION OF THE MATERIAL IN THIS DOCUMENT IS STRICTLY FORBIDDEN. PRIOR ACKNOWLEDGEMENT REQUESTED.