

DOCUMENT	BXPPABSB400600200-F01
VERSION	1.0
FORM	TECHNICAL INFORMATION



## WALL MOUNTING CABINET SERIES FLEET BLACKLINE



ORDER NO.: BXPPABSB400600200-F01

EAN: 4260543452438

### DESCRIPTION

<b>PRODUCTTYPE:</b>	WALL MOUNTING CABINET
<b>OUTER DIMENSIONS:</b>	600x400x200 mm
<b>INNER DIMENSIONS:</b>	558x351x186 mm (MINUS MOUNTING AREA)
<b>CLOSURE:</b>	DOOR WITH HINGE ON THE LONG SIDE AND 2-POINT CLOSURE
<b>COLOUR:</b>	RAL 9005 BLACK
<b>WEIGHT:</b>	6000g
<b>MATERIALS:</b>	ABS
<b>SCOPE OF DELIVERY:</b>	BASE, DOOR WITH RUBBER GASKET, MOUNTING PLATE (SHEET STEEL, GALVANIZED), 4 PCS. WALL MOUNTING BRACKET, TRIANGLE LOCKING KEY, MOUNTING SCREWS

### TECHNICAL DATA

<b>PROTECTION DEGREE:</b>	IP65
<b>IMPACT RESISTANCE:</b>	IK08
<b>OPERATING TEMPERATURE:</b>	-35°C... +65°C
<b>RESISTANCE:</b>	ALKALI, OILS, SALTS, ETC.
<b>APPROVAL:</b>	CE, ROHS

### ACCESSORIES

<b>MOUNTING PLATE:</b>	INCLUDED
<b>WALL MOUNTING BRACKET:</b>	INCLUDED
<b>SECURITY LOCK:</b>	AVAILABLE (BXPPLOCK)

RESTRICTED INFORMATION HANDED OUT BY BREUELL INGENIEURBÜRO GMBH. ANY UNAUTHORISED COPYING, DISCLOSURE OR DISTRIBUTION OF THE MATERIAL IN THIS DOCUMENT IS STRICTLY FORBIDDEN. PRIOR ACKNOWLEDGEMENT REQUESTED.

DOCUMENT	BXPPABSB400600200-F01
VERSION	1.0
FORM	TECHNICAL INFORMATION

## TECHNICAL DRAWING

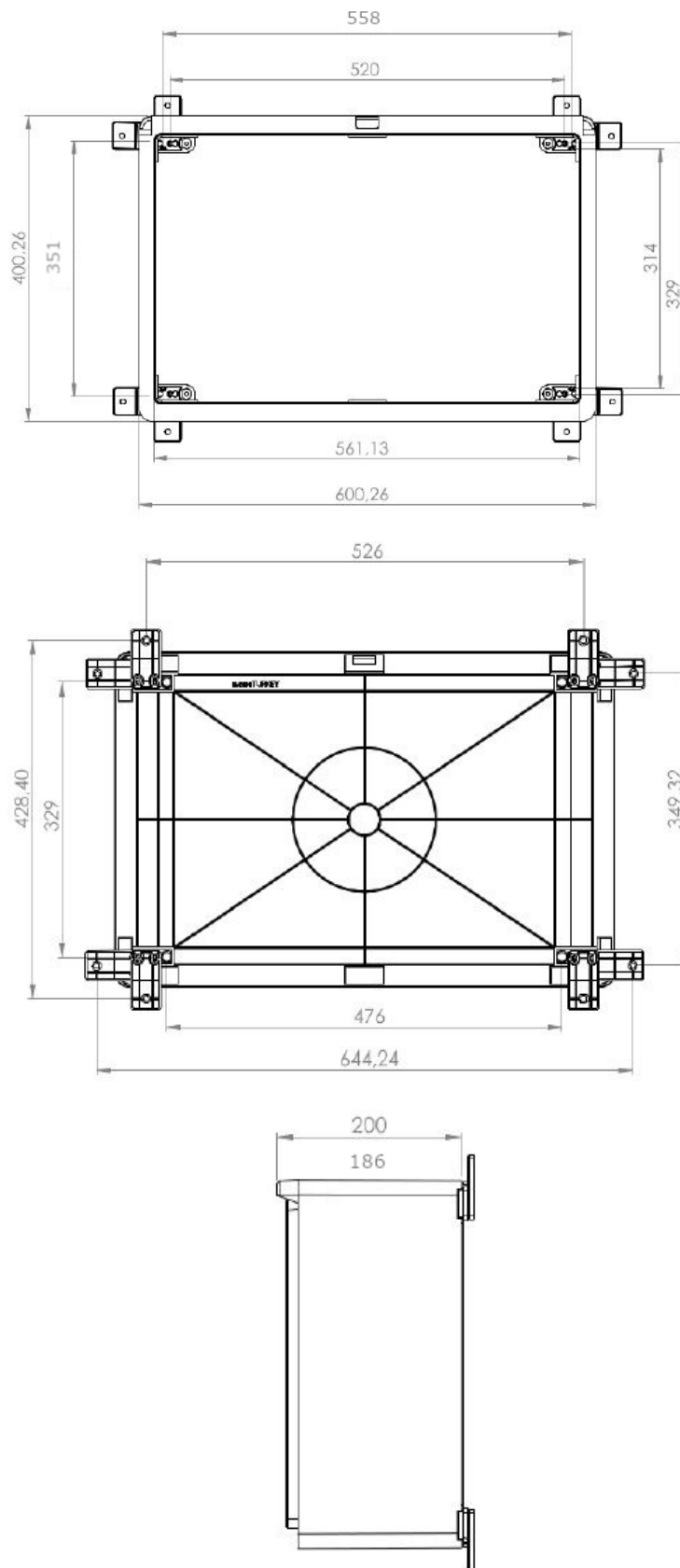

RESTRICTED INFORMATION HANDED OUT BY BREUELL INGENIEURBÜRO GMBH. ANY UNAUTHORISED COPYING, DISCLOSURE OR DISTRIBUTION OF THE MATERIAL IN THIS DOCUMENT IS STRICTLY FORBIDDEN. PRIOR ACKNOWLEDGEMENT REQUESTED.