

DOCUMENT	BXPPABST350500190-F01
VERSION	1.0
FORM	TECHNICAL INFORMATION



WALL MOUNTING CABINET SERIES FLEET BLACKLINE TRANSPARENT



ORDER NO.: BXPPABST350500190-F01

EAN: 4260543450915

DESCRIPTION

PRODUCTTYPE:	WALL MOUNTING CABINET
OUTER DIMENSIONS:	500x350x190 mm
INNER DIMENSIONS:	457x301x178 mm (MINUS MOUNTING AREA)
CLOSURE:	TRANSPARENT DOOR WITH HINGE ON THE LONG SIDE AND 2-POINT CLOSURE
COLOUR:	RAL 9005 BLACK
WEIGHT:	4300g
MATERIALS:	ABS
SCOPE OF DELIVERY:	BASE, DOOR WITH RUBBER GASKET, MOUNTING PLATE (SHEET STEEL, GALVANIZED), 4 PCS. WALL MOUNTING BRACKET, TRIANGLE LOCKING KEY, MOUNTING SCREWS

TECHNICAL DATA

PROTECTION DEGREE:	IP65
IMPACT RESISTANCE:	IK08
OPERATING TEMPERATURE:	-35°C... +65°C
RESISTANCE:	ALKALI, OILS, SALTS, ETC.
APPROVAL:	CE, ROHS

ACCESSORIES

MOUNTING PLATE:	INCLUDED
WALL MOUNTING BRACKET:	INCLUDED
SECURITY LOCK:	AVAILABLE (BXPPLOCK)

RESTRICTED INFORMATION HANDED OUT BY BREUELL INGENIEURBÜRO GMBH. ANY UNAUTHORISED COPYING, DISCLOSURE OR DISTRIBUTION OF THE MATERIAL IN THIS DOCUMENT IS STRICTLY FORBIDDEN. PRIOR ACKNOWLEDGEMENT REQUESTED.

DOCUMENT	BXPPABST350500190-F01
VERSION	1.0
FORM	TECHNICAL INFORMATION

TECHNICAL DRAWING

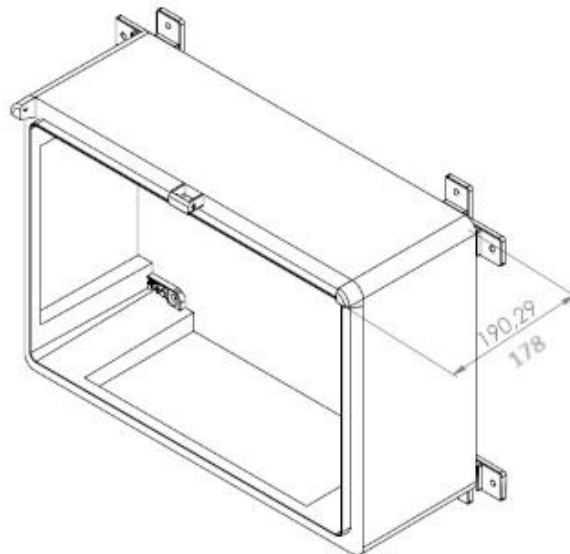
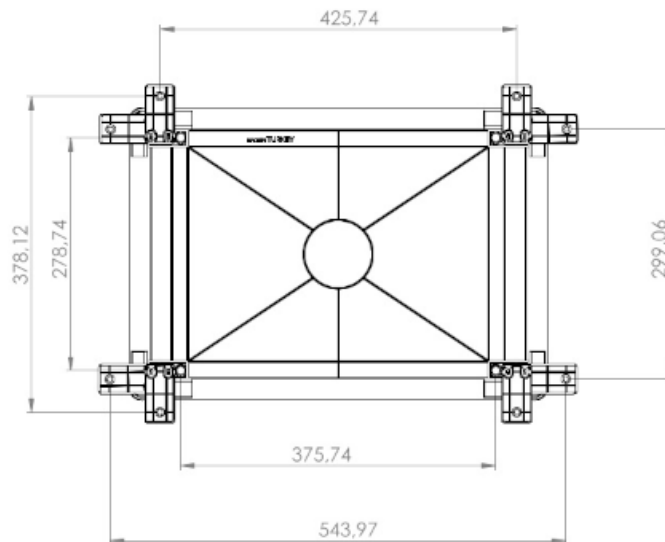
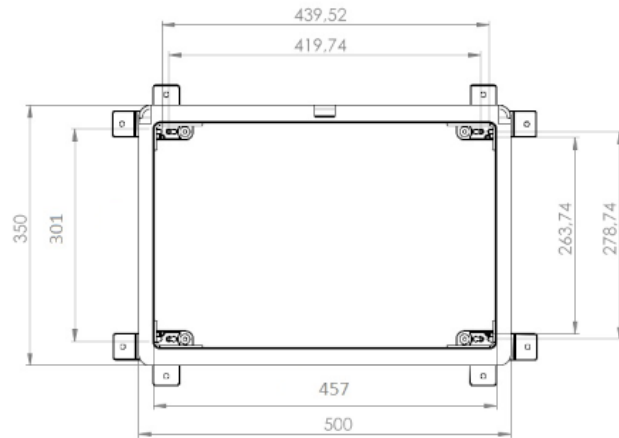

RESTRICTED INFORMATION HANDED OUT BY BREUELL INGENIEURBÜRO GMBH. ANY UNAUTHORISED COPYING, DISCLOSURE OR DISTRIBUTION OF THE MATERIAL IN THIS DOCUMENT IS STRICTLY FORBIDDEN. PRIOR ACKNOWLEDGEMENT REQUESTED.