

DOCUMENT	BXPBABS828055-E01
VERSION	1.0
FORM	TECHNICAL INFORMATION



INDUSTRIAL ENCLOSURE SERIES ELBE

ORDER NO.: BXPBABS828055-E01

EAN: 4260543450144



DESCRIPTION

PRODUCTTYPE:	INDUSTRIAL ENCLOSURE
OUTER DIMENSIONS:	82x80x55mm
INNER DIMENSIONS:	64x74x49 mm (MINUS MOUNTING AREA)
COLOUR:	RAL7015 SLATE GREY
WEIGHT:	129g
MATERIALS:	ABS
SCOPE OF DELIVERY:	UPPER AND LOWER PART, NON-RUSTING COVER SCREWS

TECHNICAL DATA

PROTECTION DEGREE:	IP65 as per DIN EN 60529/DIN 40050
IMPACT RESISTANCE:	IK 07
OPERATING TEMPERATURE:	-20°C ... +65°C WITHOUT MECHANICAL LOAD
RESISTANCE:	ALKALI, OILS, SALTS, ETC.
APPROVAL:	CE, ROHS, REACH

ACCESSORIES

MOUNTING PLATE:	AVAILABLE
MOUNTING RAIL:	AVAILABLE
CABEL GLAND:	AVAILABLE

RESTRICTED INFORMATION HANDED OUT BY BREUELL INGENIEURBÜRO GMBH. ANY UNAUTHORISED COPYING, DISCLOSURE OR DISTRIBUTION OF THE MATERIAL IN THIS DOCUMENT IS STRICTLY FORBIDDEN. PRIOR ACKNOWLEDGEMENT REQUESTED.

DOCUMENT	BXPBABS828055-E01
VERSION	1.0
FORM	TECHNICAL INFORMATION

TECHNICAL DRAWING

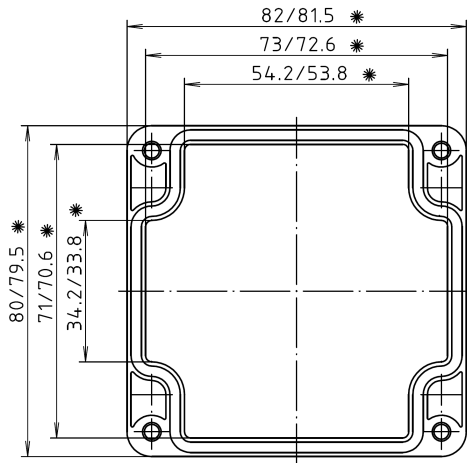

Deckel / lid

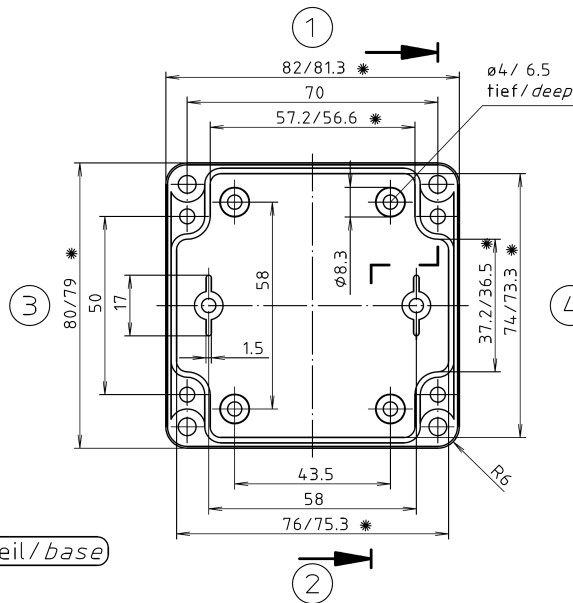

Unterteil / base

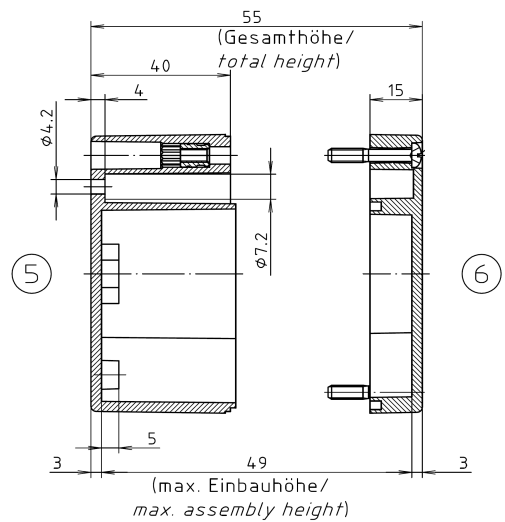

RESTRICTED INFORMATION HANDED OUT BY BREUELL INGENIEURBÜRO GMBH. ANY UNAUTHORISED COPYING, DISCLOSURE OR DISTRIBUTION OF THE MATERIAL IN THIS DOCUMENT IS STRICTLY FORBIDDEN. PRIOR ACKNOWLEDGEMENT REQUESTED.