

DOCUMENT	BXPFPCT13080100-M01
VERSION	1.0
FORM	TECHNICAL INFORMATION



## INDUSTRIAL ENCLOSURE SERIES MICHEL

ORDER NO.: BXPFPCT13080100-M01

EAN: 4260543450410



### DESCRIPTION

<b>PRODUCTTYPE:</b>	INDUSTRIAL ENCLOSURE
<b>OUTER DIMENSIONS:</b>	130x80x100 mm
<b>INNER DIMENSIONS:</b>	121x71x95,4 mm (MINUS MOUNTING AREA)
<b>CLOSURE:</b>	TRANSPARENT
<b>COLOUR:</b>	RAL7035 LIGHT GREY
<b>WEIGHT:</b>	250g
<b>MATERIALS:</b>	POLYCARBONATE
<b>SCOPE OF DELIVERY:</b>	ENCLOSURE WITH COVER, TPE SEAL, SCREWS FOR MOUNTING PLATE/DIN RAIL AND POLYAMIDE COVER SCREWS

### TECHNICAL DATA

<b>PROTECTION:</b>	IP 66 / IP 67 AS PER DIN EN 60529/DIN 40050
<b>IMPACT RESISTANCE:</b>	IK08 AS PER IEC 62262, EN 50102
<b>OPERATING TEMPERATURE :</b>	-40°C ... +80°C AS PER DIN EN 60670
<b>RESISTANCE:</b>	ALKALI, OILS, SALTS, ETC.
<b>APPROVAL:</b>	CE, ROHS

### ACCESSORIES

<b>MOUNTING PLATE:</b>	AVAILABLE
<b>MOUNTING RAIL:</b>	AVAILABLE
<b>CABEL GLAND:</b>	AVAILABLE

RESTRICTED INFORMATION HANDED OUT BY BREUELL INGENIEURBÜRO GMBH. ANY UNAUTHORISED COPYING, DISCLOSURE OR DISTRIBUTION OF THE MATERIAL IN THIS DOCUMENT IS STRICTLY FORBIDDEN. PRIOR ACKNOWLEDGEMENT REQUESTED.

DOCUMENT	BXPFPCT13080100-M01
VERSION	1.0
FORM	TECHNICAL INFORMATION

## TECHNICAL DRAWING

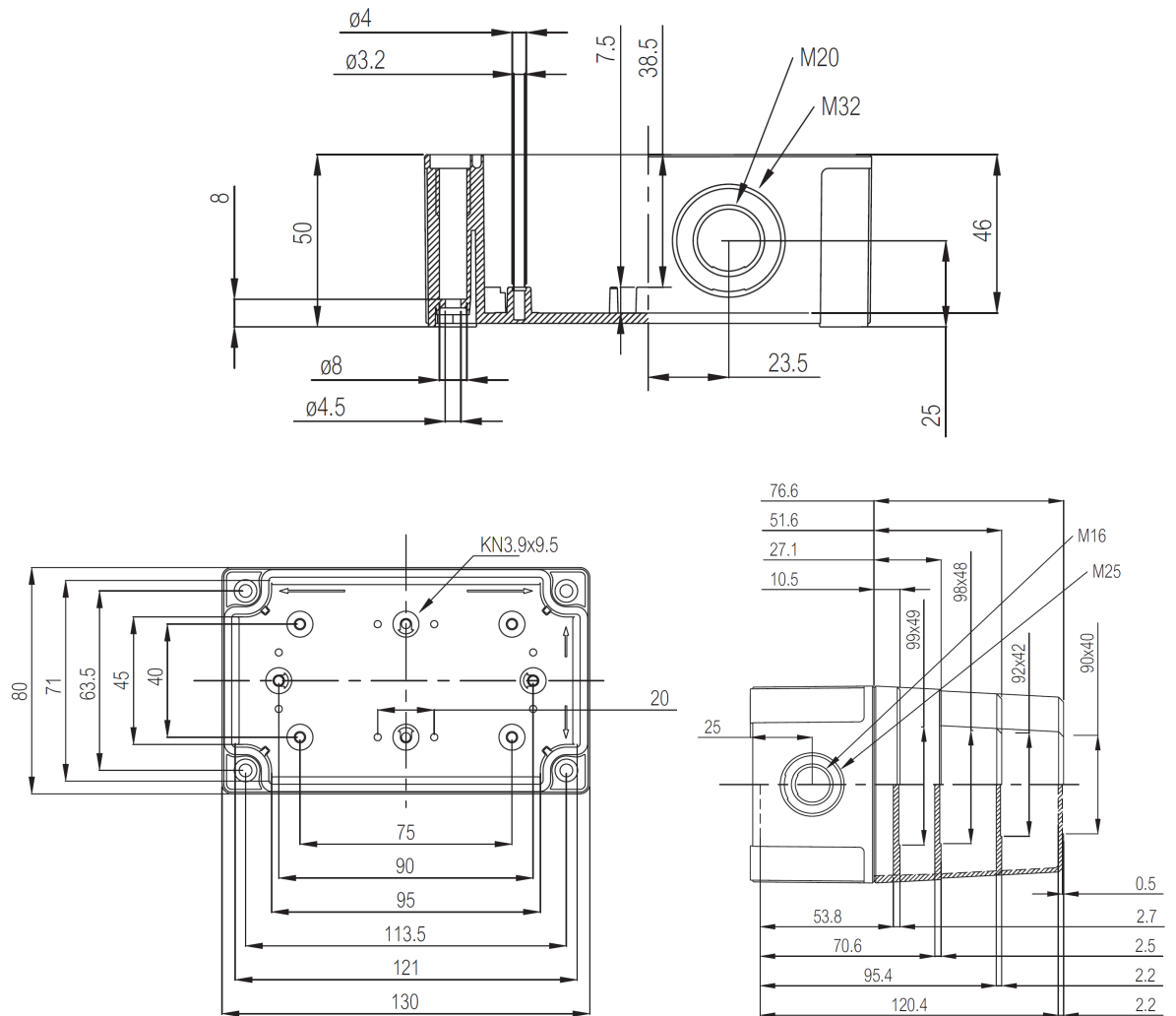

RESTRICTED INFORMATION HANDED OUT BY BREUELL INGENIEURBÜRO GMBH. ANY UNAUTHORISED COPYING, DISCLOSURE OR DISTRIBUTION OF THE MATERIAL IN THIS DOCUMENT IS STRICTLY FORBIDDEN. PRIOR ACKNOWLEDGEMENT REQUESTED.