

DOCUMENT	BXPKABS12516782-H01
VERSION	1.0
FORM	TECHNICAL INFORMATION



TERMINAL JUNCTION BOX SERIES HANSE

ORDER NO.: BXPKABS12516782-H01

EAN: 4260543451288



DESCRIPTION

PRODUCTTYPE:	TERMINAL JUNCTION BOX
OUTER DIMENSIONS:	125x167x82 mm
INNER DIMENSIONS:	118x159x72 mm (MINUS MOUNTING AREA)
COLOUR:	RAL7035 LIGHT GREY
WEIGHT:	363g
MATERIALS:	ABS
SCOPE OF DELIVERY:	INCL. BASE, COVER WITH FOAMED-IN SEAL, MOUNTING SCREWS MADE OF STAINLESS STEEL V2A, SEALING PLUG, SEALING MEMBRANE

TECHNICAL DATA

PROTECTION DEGREE:	IP66 (IP55 WITHOUT SEALING PLUG)
IMPACT RESISTANCE:	IK 07
OPERATING TEMPERATURE:	-20°C ... +40°C WITHOUT MECHANICAL LOAD
RESISTANCE:	ALKALI, OILS, SALTS, ETC.
APPROVAL:	CE, ROHS

ACCESSORIES

CABEL GLAND:	AVAILABLE
GROMMET:	INCLUDED (3 x M32, ø 9-23mm)
CONNECTION TERMINAL:	AVAILABLE (BXPKABS12516782-H02)

RESTRICTED INFORMATION HANDED OUT BY BREUELL INGENIEURBÜRO GMBH. ANY UNAUTHORISED COPYING, DISCLOSURE OR DISTRIBUTION OF THE MATERIAL IN THIS DOCUMENT IS STRICTLY FORBIDDEN. PRIOR ACKNOWLEDGEMENT REQUESTED.

DOCUMENT	BXPKABS12516782-H01
VERSION	1.0
FORM	TECHNICAL INFORMATION

TECHNICAL DRAWING

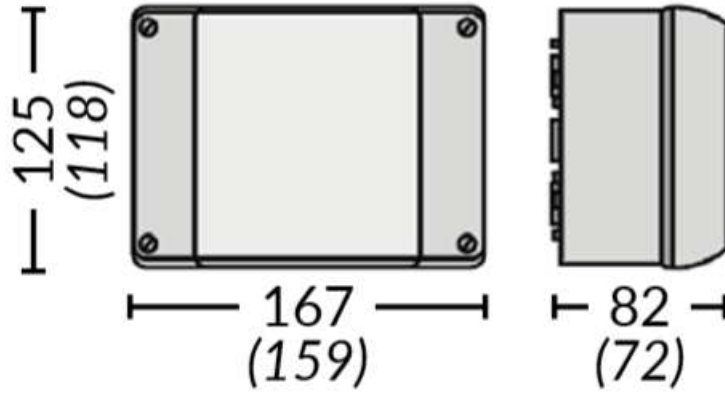

M32/40

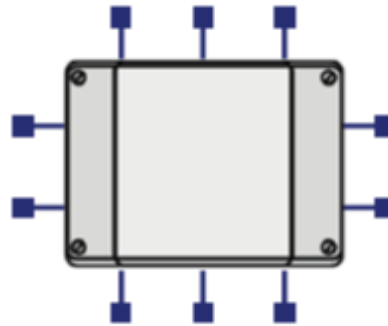

RESTRICTED INFORMATION HANDED OUT BY BREUELL INGENIEURBÜRO GMBH. ANY UNAUTHORISED COPYING, DISCLOSURE OR DISTRIBUTION OF THE MATERIAL IN THIS DOCUMENT IS STRICTLY FORBIDDEN. PRIOR ACKNOWLEDGEMENT REQUESTED.