

DOCUMENT	BXPKABS12516782-H02
VERSION	1.0
FORM	TECHNICAL INFORMATION



TERMINAL JUNCTION BOX SERIES HANSE

ORDER NO.: BXPKABS12516782-H02

EAN: 4260543451295



DESCRIPTION

PRODUCTTYPE:	TERMINAL JUNCTION BOX
OUTER DIMENSIONS:	125x167x82 mm
INNER DIMENSIONS:	118x159x72 mm (MINUS MOUNTING AREA)
COLOUR:	RAL7035 LIGHT GREY
WEIGHT:	363g
MATERIALS:	ABS
SCOPE OF DELIVERY:	INCL. BASE, COVER WITH FOAMED-IN SEAL, MOUNTING SCREWS MADE OF STAINLESS STEEL V2A, SEALING PLUG, SEALING MEMBRANE

TECHNICAL DATA

PROTECTION DEGREE:	IP66 (IP55 WITHOUT SEALING PLUG)
IMPACT RESISTANCE:	IK 07
OPERATING TEMPERATURE:	-20°C ...+40°C WITHOUT MECHANICAL LOAD
RESISTANCE:	ALKALI, OILS, SALTS, ETC.
APPROVAL:	CE, ROHS
TERMINAL TYPE:	5 POLES $\leq 10\text{MM}^2$ - 50A - AC400V 3~ $\geq 16\text{MM}^2$ - 65A - AC250V 1~

ACCESSORIES

CABEL GLAND:	AVAILABLE
GROMMET:	INCLUDED (3 x M32, \varnothing 9-23mm)
CONNECTION TERMINAL:	INCLUDED

RESTRICTED INFORMATION HANDED OUT BY BREUELL INGENIEURBÜRO GMBH. ANY UNAUTHORISED COPYING, DISCLOSURE OR DISTRIBUTION OF THE MATERIAL IN THIS DOCUMENT IS STRICTLY FORBIDDEN. PRIOR ACKNOWLEDGEMENT REQUESTED.

DOCUMENT	BXPKABS12516782-H02
VERSION	1.0
FORM	TECHNICAL INFORMATION

TECHNICAL DRAWING

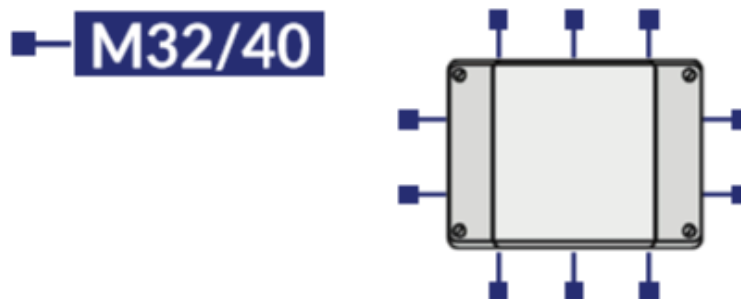
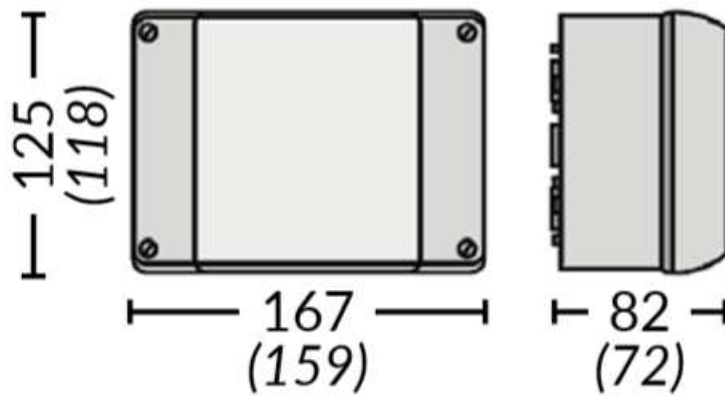

RESTRICTED INFORMATION HANDED OUT BY BREUELL INGENIEURBÜRO GMBH. ANY UNAUTHORISED COPYING, DISCLOSURE OR DISTRIBUTION OF THE MATERIAL IN THIS DOCUMENT IS STRICTLY FORBIDDEN. PRIOR ACKNOWLEDGEMENT REQUESTED.